

FUJIIRYŌKI

Fujiiryoki - Best Model

Massage Chair JP-1100

— Made in Japan —

The best* chair
That keeps getting better.



CYBER-RELAX

*Compared to our other products

Fujiiryoki has brought together the latest technology to bring you the best massage chair.

Fujiiryoki understands that “each person has different troubles”.

Some of us feel a stiffness from the neck to the upper shoulders, while some of us feel pain inside the shoulder blades.

Everyone suffers from a different problem, be it back strain, lower back pain or tired feet, depending on our lifestyle.

Fujiiryoki’s Cyber Relax Series “AS-1100” addresses each and everyone’s problems by making use of numerous sophisticated functions.

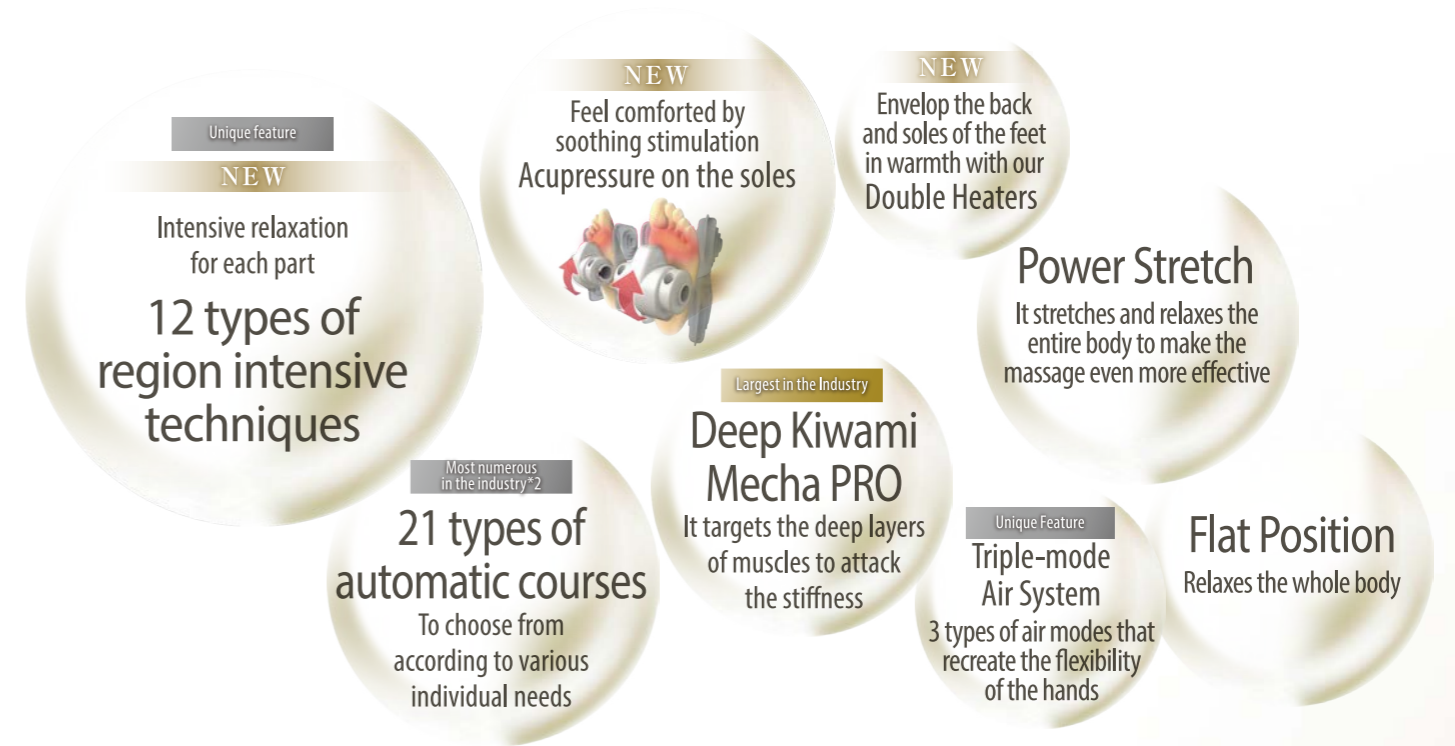





COURSE & USABILITY

Unique Feature 12 types of region intensive techniques

This offers 7 minute short courses to intensively relax the stiffness and tiredness typically experienced by people these days due to lack of exercise or desk jobs. The chair is equipped with a total of 12 types of massages – 6 region intensive massages, 3 body trunk relaxing techniques and 3 part focused stretches.



Part focused massage 6 types This offers courses to intensively relieve stiffness and tiredness.

	Neck focused massage For the tension in the back of the neck or stiffness in the neck	Massage from the back of the neck to the shoulders with stretching and loosening movements.
	Shoulder focused massage Massage targeting the shoulders	Hard massage around the shoulder with kneading and tapping movements.
	Shoulder blade focused massage For tension and fatigue of the shoulder blades	Massage from the shoulder blades to the muscles in the center of the body with stretching and relaxing movements.
	Waist focused massage For the tiredness in the waist	Massage from back to the lower back waist along the erector spinae muscles with kneading and tapping movements.
	Sciatic focused massage For the often fatigued buttocks area	Airbags on the seat thrust up for a massage with kneading and tapping movements.
	Leg focused massage For tiredness in the area behind the knees up to the soles of the feet	Massage calves with airbags. Insteps of the feet are pressed by airbags while being massaged by rollers.



region intensive stretches 3 types

This offers courses to stretch the body with stretches specialized for each body part.

-  **Neck Stretch**
It stretches the nape of the neck by fixing the neck with knead balls and extending the entire body with footrests.
-  **Back stretch**
After stretching your entire body with footrests, it lifts up and arches the back.
-  **Waist stretch**
It extends the legs and pulls them down while at the same time pushing and stretching the waist up.

NEW

NEW

Body Trunk Relaxing Techniques 3 types Takes care of the trunk to restore the body's balance.

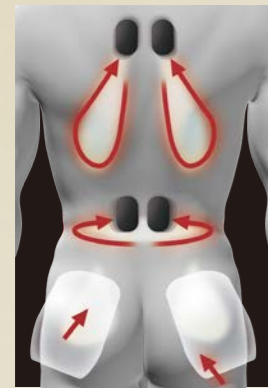

- Upper core**
For stiffness around the shoulder blades essential for maintaining posture
It grips the portion from your shoulders to the upper arms from the outside while carefully taking care of the stiffness around the shoulder blades.
- Lower core**
Care targeting the line from your waist up to the buttocks
It locks the pelvis with airbags near the waist and relaxes the muscles from the waist to the buttocks.
- Lower core stretch**
For stiffness in the muscles supporting the pelvis
It performs twisting motions with the airbags near the pelvis and gives stretch massages such as extending the muscles of the buttocks.

Most numerous in the industry 21 types of auto courses

30 minutes courses

VIP Course This course offers a 30 minute intensive massage for the whole body that is often fatigued. We bring to you quality massage time that is just like the salon.	Elite therapy course From warm-up to cool-down, this is a relaxation course in which you can enjoy luxurious comfort where it feels like you are being massaged by a number of people.	Slow Stretch This is a stretch-only course in which you can enjoy the popular stretch movements more slowly and thoroughly.	Air Relax Soothing stimulation of air massage promotes blood circulation. This is a relaxation course which relieves the stress and fatigue of the entire body.
--	--	---	---

16 minute courses

Whole body courses Effective courses when you want to massage your whole body.	Neck/shoulder courses Effective courses if you want to focus on relaxing the neck and shoulders.	Waist courses Effective courses if you want to focus on relaxing the waist area.	Stretch courses Effective courses if you want to focus on stretching.	Memory courses You can customize all the courses to create your original courses.
Deep Rejuvenation Refresh Soft	Rejuvenation Relax	Deep Rejuvenation Refresh	Rejuvenation Relax	Deep Rejuvenation Refresh
		Deep Rejuvenation Refresh	Rejuvenation Relax	Deep Rejuvenation Refresh
			Deep Whole Body Stretch Whole Body Air	Whole Body Stretch

Full Color Touch Panel Remote Control

An advanced design with a feel of luxury combining visibility and operability.



Normal Mode
Color display and simple menu enables you to choose your preferred massage with ease.

SELECT COURSE

- 30minPRO WHOLE BODY STRETCH
- NECK/SHOULDER MEMORY WAIST
- TARGET AREA MANUAL SETTING

Quick Mode
Big letters that are easy to understand. Start your massage with one touch.

QUICK MODE

- 30min ELITE THERAPY WHOLE BODY REJUVENATION COURSE
- WHOLE BODY RELAX COURSE WHOLE BODY STRETCH COURSE

CANCEL

© Can switch to English, Chinese, Korean display.

MECHANICAL MASSAGE

Largest in the Industry

Deep Kiwami Mecha PRO

Our commitment to the industry's leading Mecha is to remain constantly innovative.

We bring to you knead balls with the largest rate of protrusion in the industry (about 12.5 cm). Two knead balls move up/down, right/left and front/back and they can be controlled precisely even at that time. The mecha unit, which combines various kneading techniques, attacks the deep layers of stiffness even more deeply and delicately.

Maximum protruding capacity

Approximately **12.5cm**

Unique Feature

Double Sensing

It is equipped with 2 sensors to optimize the "depth" and "points" of the massage.

The chair is equipped with 2 sensing systems – "S-shaped line detection system" to sense the line of the spine and "shoulder position detection system" to sense the position of the shoulders. It detects the body shape in 3D to adjust the kneading perfectly for each and every person.

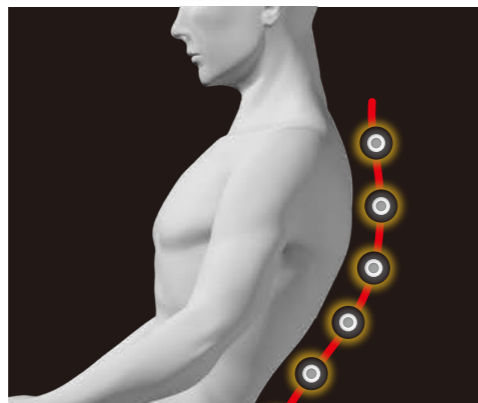

Back

Automatically detects the shape of the spine
Optimizes the "depth" of the massage

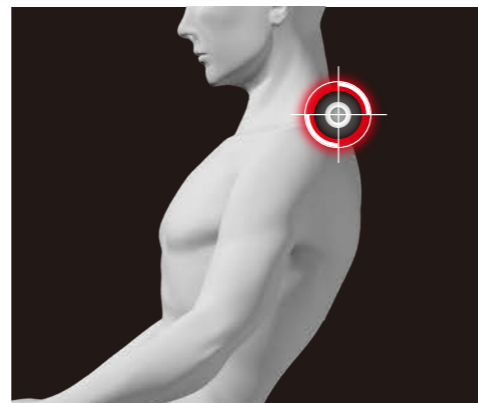

Shoulders

Automatically detects the position of the shoulders
Optimizes the "points" of the massage

Most numerous in the industry

Adjust strength up to 12 levels

It allows you to choose a suitable strength according to the stiffness you feel that day.

You can finely adjust the wide amount of protrusion of the knead balls and select your preferred strength to counter any kind of stiffness.

©Automatic course offers 7 levels, manual course has 12 levels.

Up to **12** levels When operating manually



Image Diagram

Unique Feature **Deep Layer Approach Technique**

Seven types of new kneading techniques that work on "deep layers of muscles" which create a high degree of stiffness.

The chair offers "deep layer approach techniques" to relieve the chronic stiffness experienced by people these days more deeply and delicately. Fujiiryoki brings you knead balls, with the highest rate of protrusion in the industry of about 12.5cm, that can be controlled minutely to work thoroughly on the deep layers of your muscles. From muscles behind the neck supporting the head to the deep muscles around the hips that can cause back ache, it intensively massages each part of your body.

Neck Shiatsu	Loosens and relaxes the "semispinalis capitis muscles" behind the neck that support the head.
Neck Knead	Kneads and relaxes the muscles that pull down the shoulder blades. Effective for stiffness in shoulders caused by bad posture
Inner Back Shoulder	Intensively kneads and relaxes the muscles that pull the shoulder blades back when you stretch your chest (rhomboid muscles).
Inner Back	Presses and stretches the muscles around the spinal column supporting the body.
Palm Technique (Waist)	Relaxes the deep layers of muscles that cause pain in the back or the waist.
Lumbar Shiatsu	Thoroughly presses and relaxes the muscles supporting the pelvis, like shiatsu.
Buttock	Massages deep layers of muscles around the buttocks that cause lower back pain.

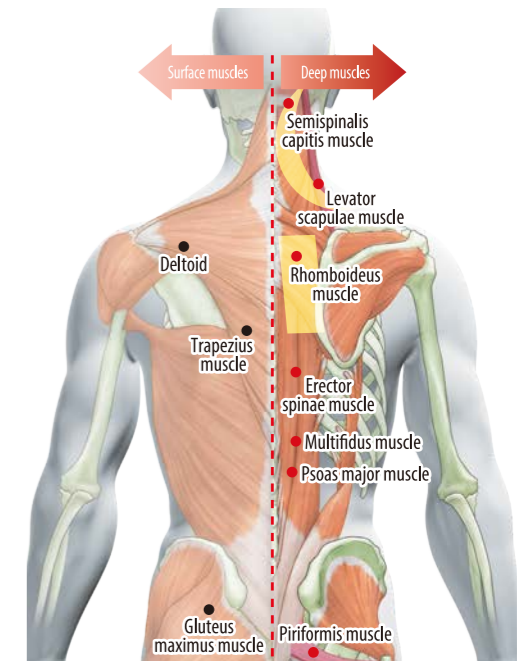

Top class in the industry

41 types, 85 kinds of kneading techniques

Offers a variety of specialized techniques targeting all the areas such as the Neck, Shoulders, Back, Waist, Hips.

Various part focused massages utilizing the kneading balls to their fullest extent. It comes with 85 top class kneading techniques, including spot-specific movements. It offers personalized special techniques such as "loop kneading" and "3D wavelet" techniques.

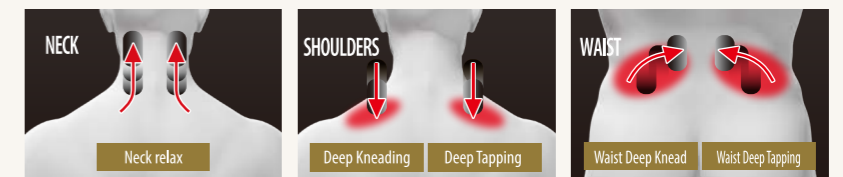

Kneading balls grasp and stretch the neck which promotes blood circulation around the neck.

Stimulates the shoulders deeply from the top to relieve the stiffness in the trapezius muscles.

Effectively relieves the waist and buttocks from fatigue and neuralgia or muscle pain.

Knead up	Knead down	Tapping	Wavelet	Relax knead up	Relax knead down	Push & knead	Palm knead up
Palm knead down	Shiatsu	Shiatsu stretch	Inner back	Rolling	Wave rolling	3D knead up	3D knead down
3D tapping	3D wavelet	Loop knead up	Loop knead down	Loop tapping	Loop wavelet	Stretch	Stretch knead up
Stretch tapping	Stretch wavelet	Neck relax	Neck shiatsu	Neck knead	Neck & shoulder deep knead	Neck & shoulder deep tapping	Shoulder tapping
Upper shoulder press	Waist deep knead	Waist deep tapping	Lumber shiatsu	Palm technique(waist)	Buttock	Shoulder blade(line)	Inner back shoulder
Shoulder blade open							

*1: As per our findings (as on May 2017)

Air Massage

Wraps your body with 31 air bags and helps you comfortably release the fatigue. To further enhance your comfort, we have installed a feature that lets you adjust the strength for each area.

Air massage is based on repeating the cycle of press and release. With the movements of our airbags that reproduce the power and flexibility of a professional hand massage and the feature that allows you select your preferred level of strength for each body part, you will experience a feeling of blissful vibrancy.

① Shoulder massage

Five-level strength adjustment

Massages by wrapping portion from your shoulders to the upper arms from the outside.



② Arm massage

Three-level strength adjustment

Massages by firmly squeezing the portion from your elbows up to the fingertips.



③ Waist/ pelvis massage

Five-level strength adjustment

Relaxes a wide range of muscles from around the pelvis to the back of the knee.



④ Leg massage

Five-level strength adjustment

Repeats the cycle of compression and release to relax your legs from calves, ankles up to the insteps of the feet.



The legs are secured with airbags on the left and right and the area around zusanli line is stimulated. Simultaneously, the airbags at the back gradually apply pressure on the back of the calves to relax them.



Unique feature Triple-mode air system

Offers 3 air modes that recreate the flexibility of a hand massage.

It comes with "flow rate adjustment function" for controlling the flow rate and speed of the air. You can choose from 3 modes as per your preference - "Hand kneading mode" that has a varied pace of a hand massage, "Pulse mode" that promotes blood circulation by supplying and releasing air little by little repeatedly, and "Normal mode" that massages the body parts intensively.

Hand Kneading Mode

Applies pressure at a varied pace while maintaining comfortable pressure.

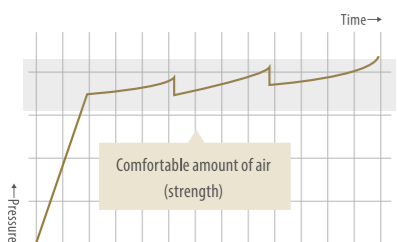

Pulse Mode

Supports promotion of blood circulation by supplying and releasing air little by little repeatedly.

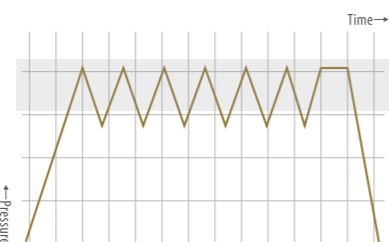

Normal Mode

Intensively massages body parts by greatly supplying and releasing air repeatedly.

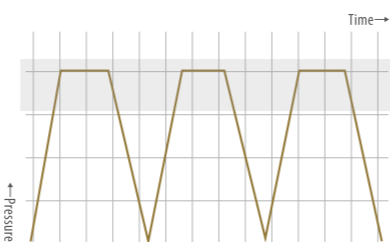

New

Foot sole shiatsu

Feet are secured between airbags near the ankles and instep and the rollers near the sole for a shiatsu massage.

Intensive massage for the soles

We use special rollers that match the arch of the feet's soles. Airbags at the ankles and insteps work in tandem, which holds your feet and gives you a massage that feels like shiatsu. And heaters at the toes help to promote blood circulation.

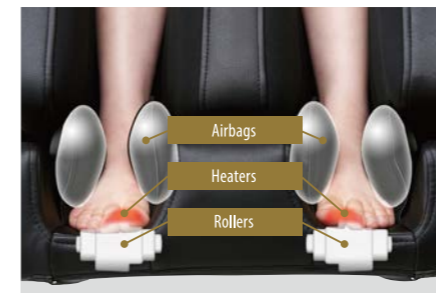

3-level strength adjustment

You can choose a strength for the rollers on the soles from 3 levels by adjusting the strength of the airbags that support your ankles up to the insteps. You can also turn off the rollers if you prefer.

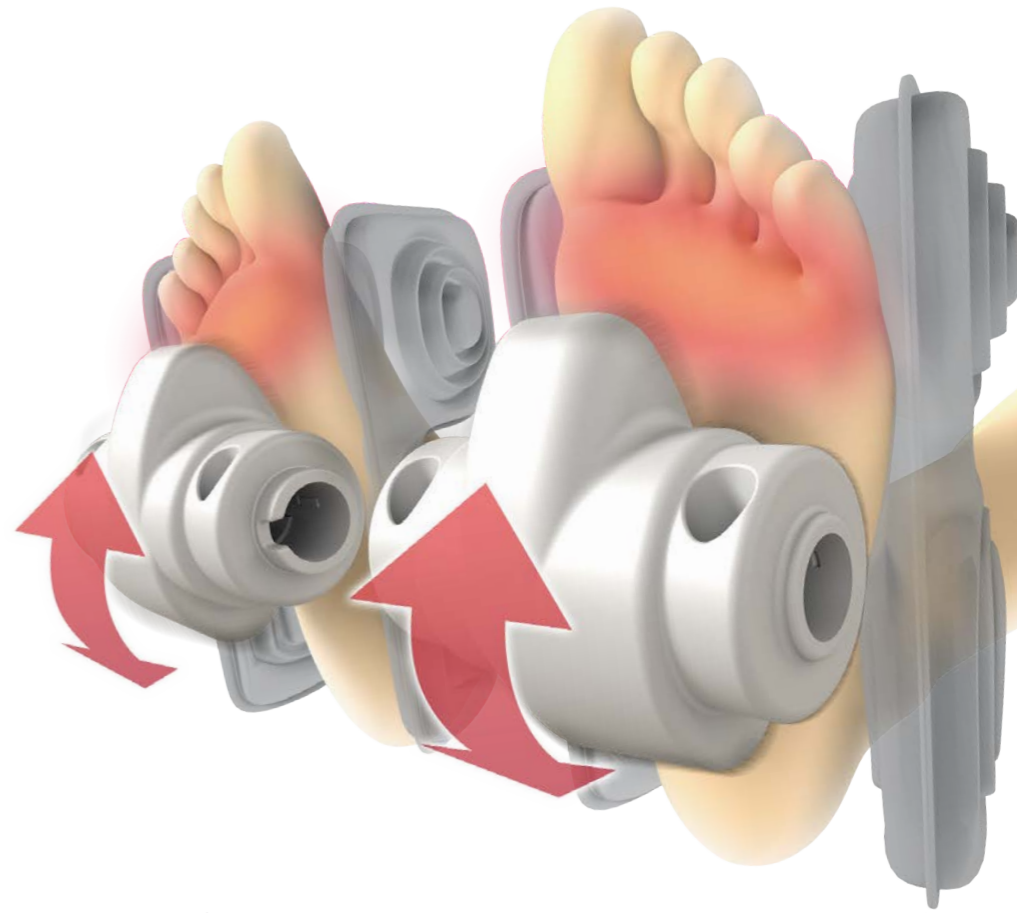

Unique shape of the rollers

Shape of the rollers offers 2 types of protrusions, high protrusion and gentle protrusion, which stretches and extends the feet from the arch to the outer side of the soles and relaxes them.

Stimulates the inside (high protrusion)

Stimulates the outside (gentle protrusion)

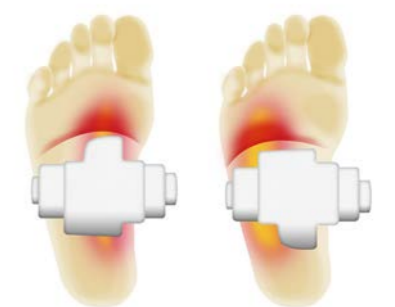

Soles of our feet are often tired as they support our whole body. It is important to relax the soles (plantar fascia).

The plantar fascia, extending from the heels to the base of the toes, is a muscle that supports the arch of the sole. It absorbs the impact of walking. It is important to massage and relieve tension from the soles of our feet which always bear the burden of our body.



Flat Position

High-quality sleeping posture to help you feel a sense of comfort. Surrender your entire body and relax.

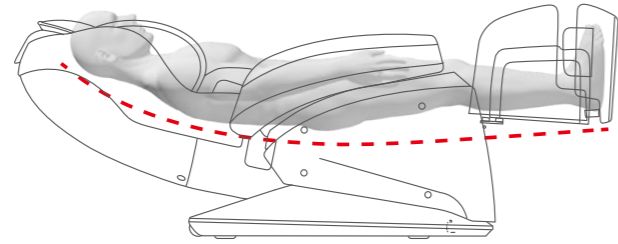

Power Stretch

A new way to loosen and relax muscles. Various new stretches to increase the effectiveness of massages.

3 types of foot stretches



Calves and sides of the waist are secured with the legs in a lowered position. Legs are stretched up by sliding.



Legs are firmly secured with airbags and pulled downwards.



Legs are secured with airbags, stretched up and then pulled down.

* Compared to our product AS-1000

Region intensive Neck Back Waist

The body is secured with airbags or knead balls and each part is powerfully stretched by pulling and stretching the legs.

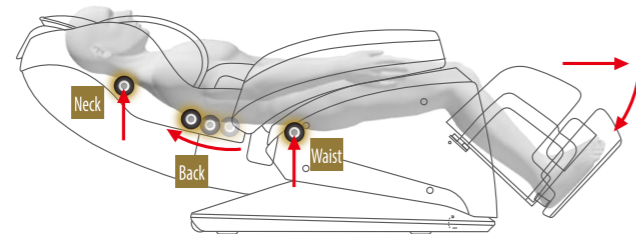

Swing stretch function

Body is secured with airbags and the backrest and leg part move up and down in tandem to thoroughly stretch the entire body.



* Incorporated in some courses

Double heaters

Two types of heaters warm up the muscles around the spinal column, which tend to stiffen, and toes, which tend to get cold.



Back center heater

Film heaters built into the back line of the backrest provide effective heating to the area around the spinal column.



Foot sole heaters

Gradually warms the toes, which tend to get cold, and relaxes them.

* It is possible to use just the heater. * Pre-set temperature: Approx. 43° (set temperature and the 'feels like' temperature varies).



Beauty along with healing.

Sophisticated design with a touch of class, will enhance the quality of your interior space. It comes in 2 colors, elegant and graceful Black and natural Beige.



Beige (CS)



Black (BK)

Fujiiryoki is recognized

World's first
Production model
massage chair

in machine inheritance!

Machine inheritance no. 68
Fuji auto massage
device World's first
Production model
Massage chair



Massage chair JP-1100

Specifications

- Main unit dimension (Approx)
(During Ottoman receiving)
Width 760 x length 1,380 x Height 1,250mm
(During maximum usage of Arm/leg)
Width 880x length 2,000 x height 740mm
- Minimum width before assembly (Approx): 680mm
- Reclining angle (Approx): 110~157 degrees
- Mass (Approx): 78kg
- Power: AC100V (50/60Hz)
- Consumption Power: 130W
(Heater: 40W) (Standby power: 0.3W)
- Rated time: 30 Minutes



black (BK)



beige (CS)



brown (BR)

[Mounting • Installation]

• Mounting width

Mounting width of the main unit It should be above 68cm+2cm (For hygiene purpose) Mounting width approximately 70cms

Mounting width approximately 70cm

• Installation

Provide the space for reclining and install on a horizontal place. More than 35cms for the foot direction and more than 50cms for the head direction are required.

[Accessories]

Detachable type back pad/pillow

Can be easily removed and attached respectively.

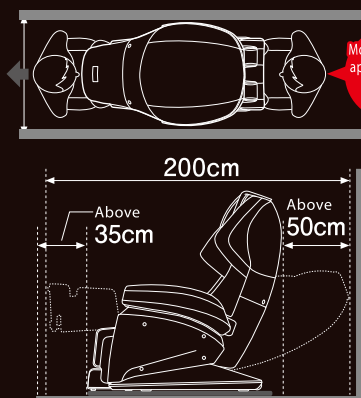

[Dimension (mm) ※approx]

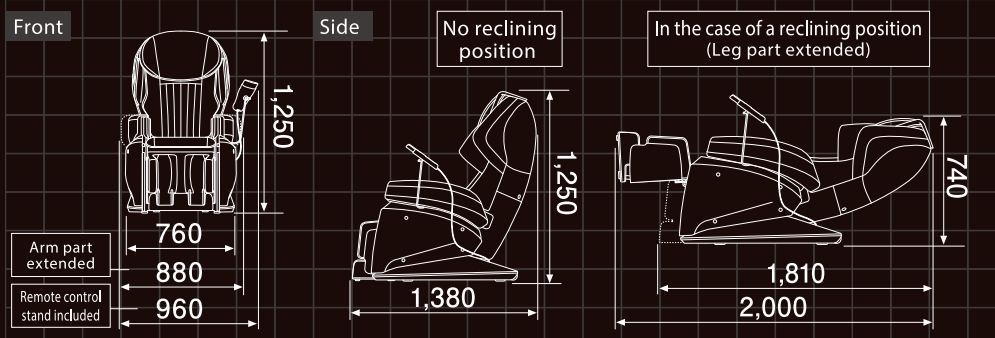

⚠ Safety warning Please read the "Operation Manual" before use and use this product properly.

■ The following persons are strongly recommended not to use this product. Certain physical abnormalities may occur.

● Persons prohibited from receiving a massage by a doctor, for example those suffering from thrombosis, severe aneurysm, Acute varicose veins, various kinds of dermatitis and skin infections (including inflammations of subcutaneous tissue), etc.

■ The following persons must consult a medical physician before using this product as certain physical abnormalities may occur. ● Persons using a medical electronic device embedded in the body such as a pacemaker susceptible to electromagnetic disturbances ● People with malignant tumor ● People with heart trouble ● Persons who are pregnant or menstruating, persons thought to be pregnant, or those immediately after childbirth. ● Persons who suffer from paresthesia related to peripheral circulatory disturbance due to diabetes etc. ● Persons with body temperature exceeding 38°C (when strong acute inflammation symptoms, malaise, chills, blood pressure fluctuations are observed, when debilitated) ● Persons with wounds in treatment areas ● Persons who suffer from acute illness (dolorific) ● Persons who suffer from osteoporosis ● Persons who suffer from spinal column fractures ● Persons suffering from inflammation such as sprains and muscle strains ● Persons who suffer from paresthesia ● Persons with abnormalities in the spine ● Persons who suffer from anemia ● Persons who need to massage a part of the body treated medically in the past ● Persons who need bed rest ● Persons receiving medical treatment ● Persons who feel an abnormality on the body apart from these.

■ Please do not allow unattended children or persons unable to declare their own intentions to use this chair. Please do not allow infants near the chair.

While using ● The remote control stand can be installed either in the left or right side.

FUJI MEDICAL INSTRUMENTS MFG. CO., LTD.

Please consult with the retailer described in the right side for the FAQs related to the details of this catalogue. Or request to the point of contact of Fujiiryoki customer.

For reformation purpose, design and specification might be changed without any prior notification. There might be slight color variations between the printed materials and actual image. Kindly acknowledge. This catalogue description is updated as on October 2015.